



LAVORAZIONI

# cornici e battiscopa

Eleganti profili modellati da abbinare nei rivestimenti ai decori, o semplicemente per arricchire di disegno una parete, creare una cornice preziosa ad una stesura murale o ad uno specchio.

Le Cornici sono fornite in moduli di lunghezza 30 cm. Le Cornici a Torciglione sono fornite pre-montate su rete in moduli da 30 cm.

Le misure riportate sono nominali.

Elegant moulded frames to be combined to decoration on coverings, or simply to enrich with design a wall, creating a precious frame for a wall covering or a mirror. Frames are supplied in modules 30 cm length. Twisted frames are net pre-mounted in 30 cm modules. Measures reported are nominal.



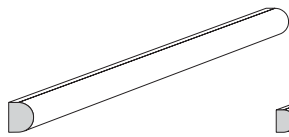

**Codice T4**  
Matita Grande  
cm 2 x 2 x 30

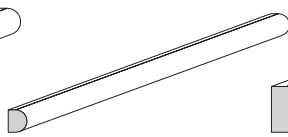

**Codice T1**  
Matita  
cm 1,5 x 1,5 x 30

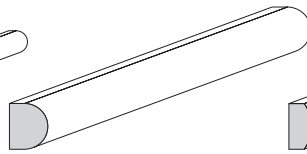

**Codice T2**  
Toro  
cm 3 x 2,5 x 30

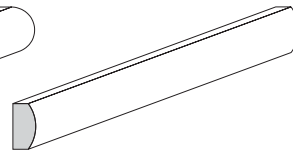

**Codice T3**  
Bombato  
cm 3 x 1,5 x 30

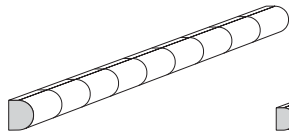

**Codice TT4**  
Matita Grande  
a Torciglione  
cm 2 x 2 x 30

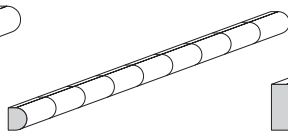

**Codice TT1**  
Matita  
a Torciglione  
cm 1,5 x 1,5 x 30

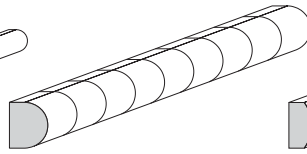

**Codice TT2**  
Toro  
a Torciglione  
cm 3 x 2,5 x 30

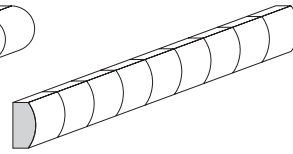

**Codice TT3**  
Bombato  
a Torciglione  
cm 3 x 1,5 x 30

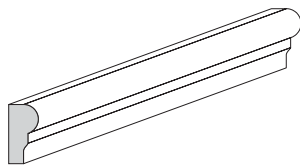

**Codice C1**  
Cornice n° 1  
cm 4 x 2 x 30

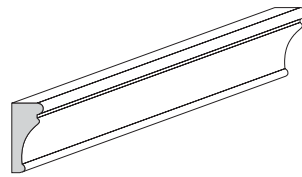

**Codice C2**  
Cornice n° 2  
cm 5 x 2,5 x 30

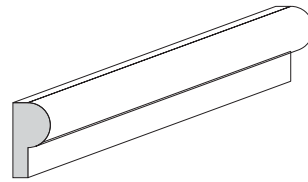

**Codice C3**  
Cornice n° 3  
cm 5 x 2,5 x 30

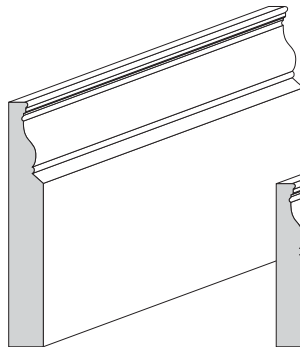

**Codice C4/3**  
Cornice n° 4  
cm 15 x 2,5 x 30

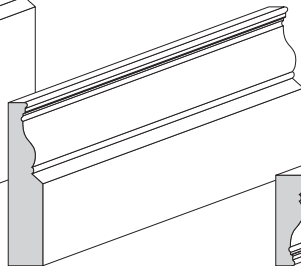

**Codice C4/2**  
Cornice n° 4  
cm 10 x 2,5 x 30

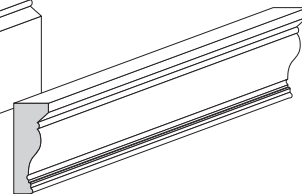

**Codice C4/1**  
Cornice n° 4  
cm 5,5 x 2,5 x 30

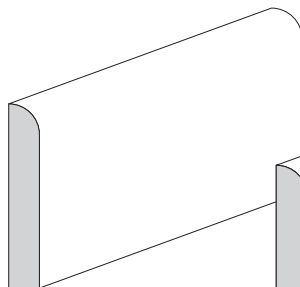

**Codice BT151**  
Battiscopa n° 1  
Modular skirting  
cm 15 x 1 x 30

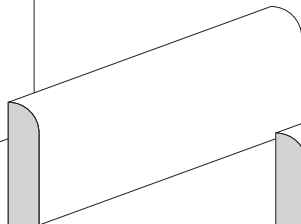

**Codice BT101**  
Battiscopa n° 2  
Modular skirting  
cm 10 x 1 x 30

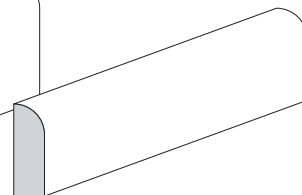

**Codice BT751**  
Battiscopa n° 3  
Modular skirting  
cm 7,5 x 1 x 30

I Battiscopa da pavimento sono disponibili nelle lunghezze di 30 e 40 cm e negli spessori di 1 e 1,5 cm.

Flooring skirting are available in different length (30 and 40 cm) and thickness (1 e 1.5 cm).

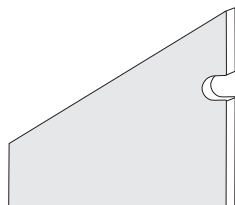

**Codice BTFA1**  
Battiscopa gradino  
Skirting step  
Fascia

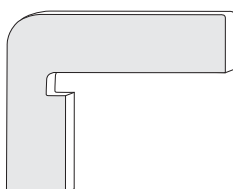

**Codice BTSA1**  
Battiscopa gradino  
Skirting step  
Sagomato

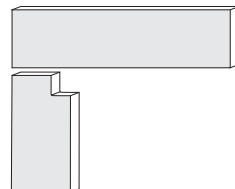

**Codice BT2PZ1**  
Battiscopa gradino  
Skirting step  
2 pezzi

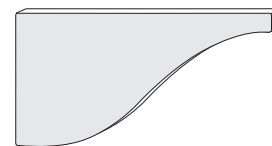

**Codice FLA1**  
Fascetta laterale  
Side band

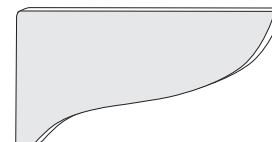

**Codice FLB1**  
Fascetta laterale  
Side band

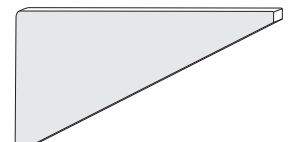

**Codice FLC1**  
Fascetta laterale  
Side band